

C  
10.5"  
267



**Hannay Reels®**  
The reel leader.

# Firefighting Reels

- | Preconnect or Storage | No Draining, Stacking, or Dragging | All Sizes and Capacities |
- | Efficient Use of Vehicle Space | Increased Hose Capacity | Faster Clean-up | ARFF |



Family owned and operated since 1933



# Contents

Reel Type	I.D. Hose Sizes	Page
<b>How to Specify Hannay Reels</b>		3
<b>Manual or Power Rewind Reels</b>		
Series F4000	3/4" or 1"	4
Series F4100	3/4" or 1"	5
Series F/SBF	3/4" or 1"	6-7
Series SF/SBSF	3/4" or 1"	8-9
Twin Fire Reel Conversion Kit		10
Series FF/SBFF - Booster Hose	1-1/4" or 1-1/2"	10-11
Collapsible Hose	1-1/2" or 1-3/4"	
Series F7100 - Dual Hose	3/4" – 1-1/2"	12-13
<b>Manual Rewind Reels</b>		
Series F3100/FF3600 - Booster Hose	3/4" – 1-1/2"	14-15
Collapsible Hose	1" – 1-3/4"	
<b>Manual or Power Rewind Reels - Large Diameter</b>		
Series LD Reels and Spools	1-1/2" – 6"	16-17
Mercedes and Niedner Altra® Capacities		18
<b>Hannay Reels Sales Policies</b>		19

## Top performance. Extreme conditions. Hannay Reels.

Safety and quick response time are critical when it comes to fighting fires. Our reels make payout and pickup quicker so you can work more efficiently and effectively when every second counts. That's why Hannay Reels is the #1 reel company specified by OEMs and professionals worldwide, based on product reliability, ease of use, and long life. When it comes to keeping your crew and your community safe, you can trust Hannay Reels.

## Attention Truck Committees and Specifiers of Fire Apparatus

Products shown and described in this catalog are suggested models for broad use applications throughout the firefighting industry. All models can be assembled to dimensionally fit your unique applications and space requirements, and all our components are designed for multiple configurations.

For special orders, contact your Hannay dealer or call our Inside Sales Group.



### Types of reels:

**Booster Hose Reels** – Quick first-attack for small fires or while larger volume hoses are being set up.

**LD (Large Diameter) Reels** – Reels for long lengths of 1-1/2" to 6" collapsible hose.

**Dual Agent Reels** – For firefighting with foam.

**Swing-Out Reels** – For aircraft rescue firefighting applications.

**Portable/Hand-held Reels** – For hose or cable applications.

### Mounting Hole Sizes

<b>Pressed Frame Reels and Channel Framed Reels</b>	<b>7/16" wide x 7/8" long slot running left to right</b>
<b>Series 4000 Reels</b>	<b>13/32" round holes</b>
<b>Series LD Reels</b>	<b>5/8" round holes</b>

# How to Specify **Hannay Reels**

## Optional Location of Components

Location of the inlet, outlet riser, and rewind mechanism can be varied to meet your requirements and **must be specified on your order**. The drawings below show the component locations. Unless otherwise specified, most reels will be shipped as **Right Top Rewind** with the inlet, outlet riser, and rewind mechanism on the operator's right.

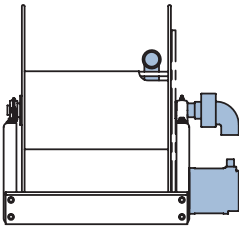

### RT – Right Top Rewind

Reels have the inlet, outlet riser, and rewind mechanism on the operator's right. Hose unwinds from the top of the reel.

Standard – Always look at your reel from this position to determine right-hand or left-hand.

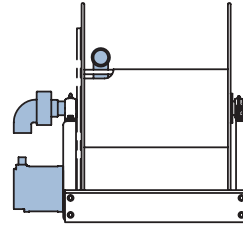

### LT – Left Top Rewind

Reels have the inlet, outlet riser, and rewind mechanism on the operator's left. Hose unwinds from the top of the reel.

Standard for 1500, 1800, 2000 & 4000 Series reels.

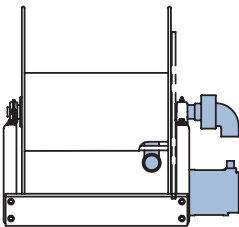

### RB – Right Bottom Rewind

Reels have the inlet, outlet riser, and rewind mechanism on the operator's right. Hose unwinds from the bottom of the reel.

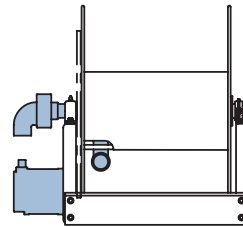

### LB – Left Bottom Rewind

Reels have the inlet, outlet riser, and rewind mechanism on the operator's left. Hose unwinds from the bottom of the reel.

**Note:** Use component location initials as suffix after model number (ie; EF32-23-24 **RT**)

## Optional Motor Locations

Electric rewind motors can be installed in any of the positions shown in these drawings. The Bottom Rear position is standard. The motor is installed inside the frame on Model ESF reels, which are designed for installation in restricted space.

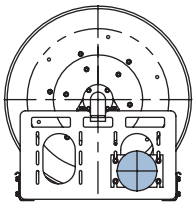

Bottom Rear (Standard)

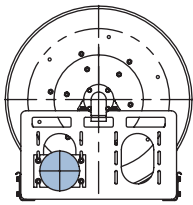

Bottom Front

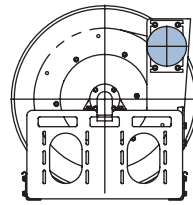

Elevated 2 O'clock (REF Reels)

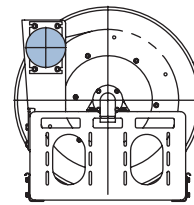

Elevated 10 O'clock (REF Reels)

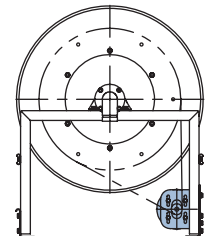

Inboard (ESF Reels)

## Optional Auxiliary Rewind Positions

Horizontal ring and pinion gear crank rewind mechanism is the standard configuration.

Optional positions include vertical and 30° above centerline, as shown in these drawings. Both are available at extra cost and **must be specified**.

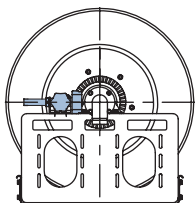

Horizontal (Standard)

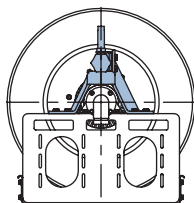

Vertical

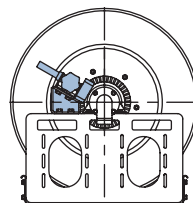

30° Angle

## Optional Roller Positions

Optional roller assembly mounting kits, up to 2 of either, can be mounted per reel. Consult factory, and indicate installation location – front or rear of reel.

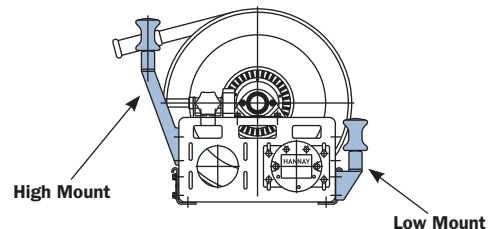

## Series F4000 | For Booster Hose

### • Compact Reels

#### To handle single 3/4" or 1" I.D. hose.

- Manual rewind reels include: cam-lock drag brake, spring actuated pin lock and removable direct crank rewind.
- Power rewind reels include: chain and sprocket drive powered by electric, hydraulic or air. Strap brake is standard.
- Standard inlet: 90° ball bearing swivel joint, 1" female NPT threads.
- Standard outlet: 1" male NST threads (1.375" x 8 threads per inch).
- Consult factory for other sizes and/or threads.
- Standard inlet, outlet riser and hub assembly are steel (also available in stainless steel).
- Rollers and roller mounting brackets are accessory items. Specify roller position.
- Standard pressures to 1000 psi (69 bar).
- Standard fluid temperatures from -15° F to +250° F (-26° C to +121° C).
- Consult factory for other pressures and temperatures.



Standard configuration shown with Electric Rewind (E) option

**CAUTION:** F4000/F4100 Series reels **not** recommended for use with Niedner|Altra® hose. See page 18.

#### PARTS DRAWING – ISO 68



#### Optional External Mounting Brackets

Part No. 9906.0025.

Add 2-1/2" to the X dimensions shown in the chart.

Model Number For power rewind see Note 5	Hose Capacity of Reel feet m			Approx. Weight Crank Rewind lb. kg see Note 3			Reel Dimensions*** In. mm						
	I.D. in. mm	3/4 19	1 25	NET	UPS/ FedEx SHIP WT.	Freight SHIP WT.	A	B	E CRANK	E POWER	F CRANK	F POWER	X
	O.D. in. mm	1-9/32 33	1-1/2 38										
F4018-17-18		50	35	36	80*	71	15	10	17.5	19	26.5	20.75	13.5
		15	11	16	36	32	381	254	445	483	673	527	343
F4024-17-18		100	50	46	83*	81	21	16	17.5	19	32.5	26.75	19.5
		30	15	21	38	37	533	406	445	483	826	679	495
F4030-17-18		150	75	57	110*	92	27	22	17.5	19	38.5	32.75	25.5
		46	23	26	50	42	686	559	445	483	978	832	648
F4038-17-18		200	100	70	-	125	35	30	17.5	19	46.5	40.75	33.5
		61	30	32	-	57	889	762	445	483	1181	1035	851

#### Notes:

1. Specifications subject to change.
2. Upon request, reels can be supplied with drum lengths other than shown and with disc sizes in other diameters.
3. Weights shown in chart are for crank rewind models. ADD these amounts for power rewind models. (does not apply to FedEx or UPS):
 

	Net lbs/kg	Ship lbs/kg
Electric	18/8.2	18/8.2
Hydraulic	15/6.8	15/6.8
Air	15/6.8	15/6.8
4. Dimension "F" is the overall length of standard model reels. On crank rewind models, the dimension shown is with the crank in rewind position. Reels require 3-1/2" clearance to remove crank handle.
5. When ordering power rewind models, prefix model number with:
  - A = Air Rewind – supplied with control valve and 18" air hose.
  - E = Electric Rewind (1/3 HP) – 12v and 24v DC rewind reels supplied with switch and solenoid. 115v AC rewind reels are not supplied with switch, but can be ordered separately.
  - HD = Hydraulic Rewind – not supplied with control valve.
6. Be sure to check dimensions and weights prior to ordering.
7. Some roller options may prohibit the use of our molded chain guard.

**NOTICE:** A flexible connector must be used between the inlet pipe and the inlet swivel joint.

\*Dimensional weight applies when shipped as a parcel package (via FedEx or UPS Ground).

\*\*\* X, Y indicate mounting holes.

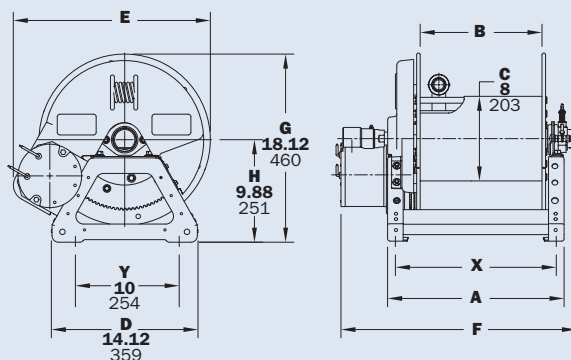

# Series F4100

**To handle single 3/4" or 1" I.D. hose.**

- Lightweight, compact reels designed for long lengths of hose in manual and power rewind.
- Gear-driven crank rewind with removable handle and adjustable brake is standard.
- Power rewind reels include: chain and sprocket drive powered by electric, hydraulic or air motor.
- Standard inlet: 90° ball bearing swivel joint, 1" female NPT threads.
- Standard outlet: 1" male NST threads.
- Rollers and roller mounting brackets are accessory items. Specify roller position.
- Standard pressures to 1000 psi (69 bar).
- Standard fluid temperatures from -15° F to +250 °F (-26° C to +121° C).
- Consult factory for other pressures and temperatures.



Standard configuration shown with Electric Rewind (E) option and gear-driven crank rewind

**CAUTION:** F4000/F4100 Series reels **not** recommended for use with Niedner|Altra® hose. See page 18.

**PARTS DRAWING – ISO 216**

Model Number <small>For power rewind see Note 5</small>	Hose Capacity of Reel feet m			Approx. Weight Crank Rewind lb. kg <small>see Note 3</small>		Reel Dimensions*** in. mm					
	I.D. in. mm	3/4 19	1 25	NET	SHIP	A	B	E CRANK	E POWER	F	X
	O.D. in. mm	1-9/32 33	1-1/2 38								
<b>F4118-17-18</b>	<b>50</b> 15	<b>35</b> 11	<b>25</b> 11	<b>62</b> 28	<b>97</b> 44	<b>15</b> 381	<b>10</b> 254	<b>18</b> 457	<b>20.5</b> 521	<b>21.5</b> 546	<b>7.5</b> 190
<b>F4124-17-18</b>	<b>100</b> 30	<b>50</b> 15	<b>72</b> 15	<b>72</b> 33	<b>107</b> 49	<b>21</b> 533	<b>16</b> 406	<b>18</b> 457	<b>20.5</b> 521	<b>27.5</b> 699	<b>13.5</b> 343
<b>F4130-17-18</b>	<b>150</b> 46	<b>75</b> 23	<b>83</b> 23	<b>83</b> 38	<b>118</b> 54	<b>27</b> 686	<b>22</b> 559	<b>18</b> 457	<b>20.5</b> 521	<b>33.5</b> 851	<b>19.5</b> 495
<b>F4138-17-18</b>	<b>200</b> 61	<b>100</b> 30	<b>96</b> 30	<b>96</b> 44	<b>131</b> 59	<b>35</b> 889	<b>30</b> 762	<b>18</b> 457	<b>20.5</b> 521	<b>41.5</b> 1054	<b>27.5</b> 698

<b>Notes:</b>		<p>5. When ordering power rewind models, prefix model number with:</p> <p><b>A</b> = Air Rewind – supplied with control valve and 18" air hose.</p> <p><b>E</b> = Electric Rewind (1/3 HP) – 12v and 24v DC rewind reels supplied with switch and solenoid. 115v AC rewind reels are not supplied with switch, but can be ordered separately.</p> <p><b>HD</b> = Hydraulic Rewind – not supplied with control valve.</p> <p>6. <b>Be sure to check dimensions and weights prior to ordering.</b></p>											
1. Specifications subject to change.													
2. Upon request, reels can be supplied with drum lengths other than shown.													
3. Weights shown in chart are for crank rewind models. ADD these amounts for power rewind models:	<table border="1"> <tr> <td></td> <td>Net lbs/kg</td> <td>Ship lbs/kg</td> </tr> <tr> <td><b>Electric</b></td> <td><b>18/8.2</b></td> <td><b>18/8.2</b></td> </tr> <tr> <td><b>Hydraulic</b></td> <td><b>15/6.8</b></td> <td><b>15/6.8</b></td> </tr> <tr> <td><b>Air</b></td> <td><b>15/6.8</b></td> <td><b>15/6.8</b></td> </tr> </table>			Net lbs/kg	Ship lbs/kg	<b>Electric</b>	<b>18/8.2</b>	<b>18/8.2</b>	<b>Hydraulic</b>	<b>15/6.8</b>	<b>15/6.8</b>	<b>Air</b>	<b>15/6.8</b>
	Net lbs/kg	Ship lbs/kg											
<b>Electric</b>	<b>18/8.2</b>	<b>18/8.2</b>											
<b>Hydraulic</b>	<b>15/6.8</b>	<b>15/6.8</b>											
<b>Air</b>	<b>15/6.8</b>	<b>15/6.8</b>											
4. Dimension "F" is the overall length of standard model reels.													
<b>NOTICE:</b> A flexible connector must be used between the inlet pipe and the inlet swivel joint.													
*** X, Y indicate mounting holes.													



## Series **F/SBF** | For Booster Hose

### To handle 3/4" or 1" I.D. hose.

- Standard booster hose reel is steel, painted graphite. Aluminum or stainless steel construction is also available.
- Super Booster (SBF) polished aluminum construction reel weighs up to 30% less than standard booster reel. Prefix complete model number with "SB" when ordering. See Note 6 on page 7.
- Gear-driven crank rewind is standard. Choose chain and sprocket drive powered by electric, hydraulic or compressed air motor.
- Pinion brake standard.
- Standard inlet: 1" 90° ball bearing swivel joint with 1" female NPT threads.
- Standard outlet: 1" male NST threads. (1.375" x 8 threads per inch.)
- Consult factory for other sizes and/or threads.
- Standard inlet, outlet riser, and hub assembly are steel (also available in stainless steel).
- Rollers and roller mounting brackets are accessory items. Specify roller position.
- Standard pressures to 1000 psi (69 bar).
- Standard fluid temperatures from -15° F to +250 °F (-26° C to +121° C).
- Consult factory for reels to operate at other pressures and temperatures.

**CAUTION:** When using Niedner|Altra® hose, a special riser and/or larger drum diameter is required.

See chart for capacity on page 18, or consult factory.



Shown with Electric Rewind (E), optional red finish and optional roller and spool assembly

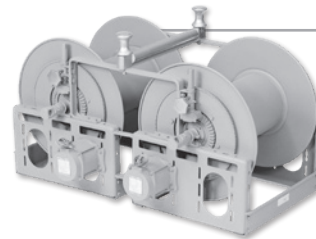

**Twin Fire Reel Conversion Kit is also available. Refer to page 10.**

### Hub Assembly Options

The hub assembly is the heart of the hose reel. It includes the outlet riser, the reel axle, and the threaded inlet to which the swivel joint is attached. The swivel joint permits the reel to rotate freely while connected to the fluid source.

The outlet riser is engineered to conform to the contour of the drum so the hose lies smoothly against the drum without kinking. Smooth interior surfaces are flow-contoured for unrestricted flow and minimal pressure loss through the reel.

A 2-way flow hub assembly is available on certain models as an option. On this assembly, the reel axle is threaded on both ends so the swivel joint can be attached at either end to match piping. A pipe cap is supplied to seal the opposite end.

#### Standard Hub Assembly

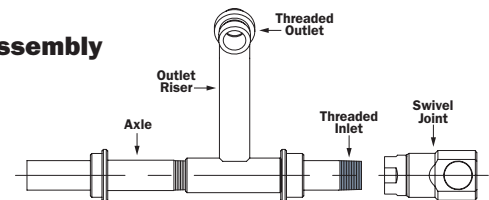

#### Standard Hub Assembly with Optional Flanged Riser

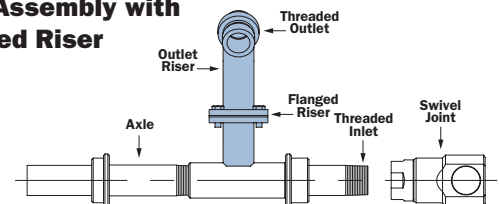

#### Optional 2-Way Hub Assembly with Optional Flanged Riser

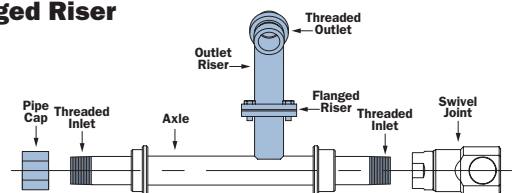

**PARTS DRAWING: SERIES F – ISO 84; SERIES SBF SUPER BOOSTER® – ISO 122**

Model Number <small>For power rewind see Note 5</small>	Hose Capacity of Reel feet m			Approx. Weight Crank Rewind lb. kg <small>see Note 4</small>				Reel Dimensions*** In. mm									
	I.D. in. mm	3/4 19	1 25	STEEL		ALUMINUM <small>see Note 6</small>		A	B	D	E	F CRANK	F POWER	G	H	X	Y
	O.D. in. mm	1-9/32 33	1-1/2 38	NET	SHIP	NET	SHIP										
<b>*F32-19-21</b>	175 53	85 26	102 46	144 65	86 39	128 58	29.5 749	24 610	20.5 521	21.62 549	34.25 870	34.38 873	21.5 546	12.12 308	12.12 308	21.5 546	16.75 425
<b>*F24-23-24</b>	150 46	125 38	92 42	134 61	79 36	121 55	21 533	15.5 394	20.5 521	23 584	25.75 654	25.88 657	23.5 597	12.12 308	12.12 308	13 330	16.75 425
<b>F30-23-24</b>	225 68	200 61	105 48	147 67	88 40	130 59	27.5 699	22 559	20.5 521	23 584	32.25 819	34.25 867	23.5 597	12.12 308	12.12 308	19.5 495	16.75 425
<b>F38-23-24</b>	300 91	250 76	120 54	162 73	100 45	142 64	35 889	29.5 749	20.5 521	23 584	39.75 1010	41.75 1060	23.5 597	12.12 308	12.12 308	27 686	16.75 425
<b>F28-25-26</b>	275 84	175 53	113 51	155 70	93 42	135 62	25.5 648	20 508	25.5 648	24.75 629	30.25 768	32.25 819	27.88 708	15.5 394	15.5 394	17.5 445	21.75 552
<b>F34-25-26</b>	350 107	250 76	126 57	168 76	99 45	141 64	31.5 800	26 660	25.5 648	24.75 629	36.25 921	38.25 972	27.88 708	15.5 394	15.5 394	23.5 597	21.75 552
<b>*F16.5-30-31</b>	175 53	125 38	100 45	150 68	83 38	133 60	13.5 343	8 203	25.5 648	28.75 730	18.25 464	18.38 467	29.88 759	15.5 394	15.5 394	5.5 140	21.75 552
<b>*F20-30-31</b>	250 76	150 46	107 49	157 71	87 39	137 62	17 432	11.5 292	25.5 648	28.75 730	21.75 552	21.88 556	29.88 759	15.5 394	9 229	21.75 552	
<b>F24-30-31</b>	350 107	250 76	113 51	163 74	91 41	141 64	21 533	15.5 394	25.5 648	28.75 730	25.75 654	27.75 705	29.88 759	15.5 394	13 330	21.75 552	
<b>F28-30-31</b>	-	300 91	121 55	171 78	96 43	146 66	25.5 648	20 508	25.5 648	28.75 730	30.25 768	32.25 819	29.88 759	15.5 394	15.5 394	17.5 445	21.75 552
<b>F34-30-31</b>	-	350 107	134 61	184 83	103 47	153 69	31.5 800	26 660	25.5 648	28.75 730	36.25 921	38.25 972	29.88 759	15.5 394	15.5 394	23.5 597	21.75 552
<b>F20-33-34</b>	300 91	200 61	107 49	157 71	87 39	137 62	16.5 419	11.5 292	31.5 800	31.75 806	21.12 536	23.25 591	33.62 854	17.75 451	9 229	27.75 705	

**Notes:**

- Specifications subject to change.
- A 2-way flow hub is available and must be specified. Assembly is threaded on both ends so swivel joint can be attached at either end of the reel. A pipe cap seals the opposite end. (See Ordering & Accessory Guide.)
- Upon request, reels can be supplied with drum lengths other than shown and with disc sizes in other diameters.
- Weights shown in chart are for crank rewind models. ADD these amounts for power rewind models:
 

	Net lbs/kg	Ship lbs/kg
Electric	40/18.1	40/18.1
Hydraulic	20/9.1	20/9.1
Air	20/9.1	20/9.1
- When ordering power rewind models, prefix model number with:
  - A** = Air Rewind – supplied with control valve and 18" air hose.
  - E** = Electric Rewind (1/3 HP)
  - EP** = Electric Rewind (1/2 HP) – 12v and 24v DC rewind reels supplied with switch and solenoid. 115v AC rewind reels are not supplied with switch, but can be ordered separately.
  - HD** = Hydraulic Rewind – not supplied with control valve.
- For polished aluminum reels, prefix complete model number with "SB" (for example: SBEF 32-19-21).
- When installing FH-3 rollers, add 4-1/2" to the "D" dimension.
- Be sure to check dimensions and weights prior to ordering.**

**NOTICE:** A flexible connector must be used between the inlet pipe and the inlet swivel joint.

\*The "F" dimension for these models is shown for 1/3 HP motors. Add 2" to "F" dimension for 1/2 HP motors. The "F" dimension for all other reels is shown for 1/2 HP. Reels handling 175' or more must use 1/2 HP motor. (Use prefix EP when ordering.)

\*\*\* X, Y indicate mounting holes.

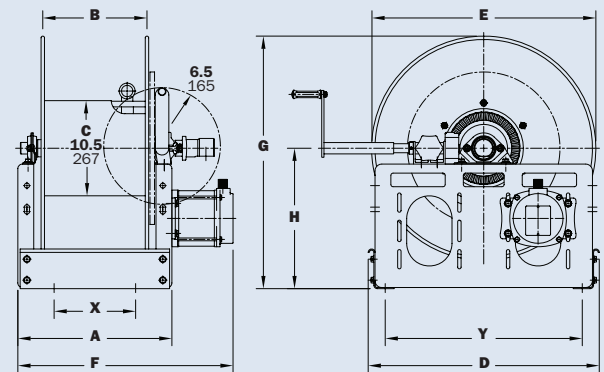

# Series **SF/SBSF** | For Booster Hose

• **Inboard Mounted Motor**

**To handle 3/4" or 1" I.D. hose.**

- Inboard motor location high profile.
- Standard booster hose reel is steel, painted graphite. Aluminum or stainless steel construction is also available.
- Super Booster (SBSF) polished aluminum construction reel weighs up to 30% less than standard booster reel. Prefix complete model number with "SB" when ordering. See Note 6 on page 9.
- Choose chain and sprocket rewind powered by either electric or compressed air motor.
- Pinion brake standard.
- Standard inlet: 1" 90° ball bearing swivel joint with 1" female NPT threads.
- Standard outlet: 1" male NST threads (1.375" x 8 threads per inch).
- Consult factory for other sizes and/or threads.
- Standard inlet, outlet riser, and hub assembly are steel (also available in stainless steel).
- Rollers and roller mounting brackets are accessory items. Specify roller position.
- Standard pressures to 1000 psi (69 bar).
- Standard fluid temperatures from -15° F to +250 °F (-26° C to +121° C).
- Consult factory for other pressures and temperatures.

**CAUTION:** When using Niedner|Altra® hose, a special riser and/or larger drum diameter is required.

See chart for capacity on page 18, or consult factory.



Standard configuration shown with Manual Rewind

## Hub Assembly Options

The hub assembly is the heart of the hose reel. It includes the outlet riser, the reel axle, and the threaded inlet to which the swivel joint is attached. The swivel joint permits the reel to rotate freely while connected to the fluid source.

The outlet riser is engineered to conform to the contour of the drum so the hose lies smoothly against the drum without kinking. Smooth interior surfaces are flow-contoured for unrestricted flow and minimal pressure loss through the reel.

A 2-way flow hub assembly is available on certain models as an option. On this assembly, the reel axle is threaded on both ends so the swivel joint can be attached at either end to match piping. A pipe cap is supplied to seal the opposite end.

### Standard Hub Assembly

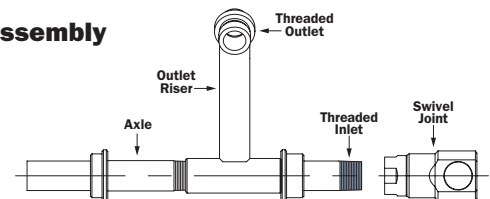

### Standard Hub Assembly with Optional Flanged Riser

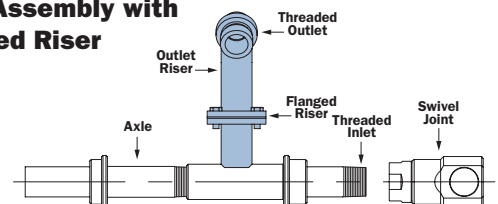

### Optional 2-Way Hub Assembly with Optional Flanged Riser

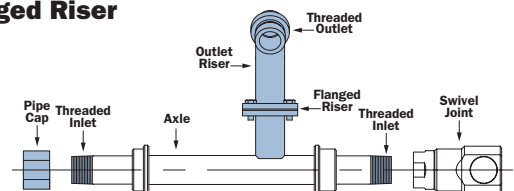



For Booster  
Hose

**Series SF/SBSF**

• Inboard Mounted Motor

**PARTS DRAWING – ISO 220**

Model Number For power rewind see Note 5	Hose Capacity of Reel feet m			Approx. Weight Crank Rewind lb. kg see Note 4				Reel Dimensions*** in. mm								
	I.D. in. mm	3/4 19	1 25	STEEL		ALUMINUM see Note 6		A	B	D	E	F	G	H	X	Y
				NET	SHIP	NET	SHIP									
SF32-19-21	175	85		102	144	80	122	29	24	20.5	21.62	34	25.12	15.75	21.5	16.75
	53	26		46	65	36	55	737	610	521	549	864	638	400	546	425
SF24-23-24	150	125		92	134	75	117	20.5	15.5	23.5	23	25.5	29.25	17.88	13	19.75
	46	38		42	61	34	53	521	394	597	584	648	743	454	330	502
*SF30-23-24	225	200		105	147	82	124	27	22	23.5	23	32	29.25	17.88	19.5	19.75
	68	61		48	67	37	56	686	559	597	584	813	743	454	495	502
*SF28-25-26	275	175		113	155	87	129	25	20	25.5	24.75	30	30.88	18.5	17.5	21.75
	84	53		51	70	39	59	635	508	648	629	762	784	470	445	552
*SF34-25-26	350	250		126	168	93	135	31	26	25.5	24.75	36	30.88	18.5	23.5	21.75
	107	76		57	76	42	61	787	660	648	629	914	784	470	597	552
SF16.5-30-31	175	125		100	150	80	130	13	8	29	28.75	18	35.62	21.25	5.5	25.25
	53	38		45	68	36	59	330	203	737	730	457	905	540	140	641
SF20-30-31	250	150		107	157	83	133	16.5	11.5	29	28.75	21.5	35.62	21.25	9	25.25
	76	46		49	71	38	60	419	292	737	730	546	905	540	229	641
*SF24-30-31	350	250		113	163	87	137	20.5	15.5	29	28.75	25.5	35.62	21.25	13	25.25
	107	76		51	74	39	62	521	394	737	730	648	905	540	330	641
*SF28-30-31	-	300		121	171	90	140	25	20	29	28.75	30	35.62	21.25	17.5	25.25
	-	91		55	78	41	64	635	508	737	730	762	905	540	445	641
*SF34-30-31	-	350		134	184	97	147	31	26	29	28.75	36	35.62	21.25	23.5	25.25
	-	107		61	83	44	67	787	660	737	730	914	905	540	597	641
*SF20-33-34	300	200		117	167	90	140	16.5	11.5	31.5	31.75	21.12	38.12	22.25	9	27.88
	91	61		53	76	41	64	419	292	800	806	536	968	565	229	708

**Notes:**

- Specifications subject to change.
- A 2-way flow hub is available and must be specified. Assembly is threaded on both ends so swivel joint can be attached at either end of the reel. A pipe cap seals the opposite end. (See Ordering & Accessory Guide.)
- Upon request, reels can be supplied with drum lengths other than shown and with disc sizes in other diameters.
- Weights shown in chart are for crank rewind models. ADD these amounts for power rewind models (does not apply to FedEx or UPS):
 

	Net lbs/kg	Ship lbs/kg
Electric	40/18.1	40/18.1
Hydraulic	20/9.1	20/9.1
Air	20/9.1	20/9.1
- When ordering power rewind models, prefix model number with:
  - A** = Air Rewind – supplied with control valve and 18" air hose.
  - E** = Electric Rewind (1/3 HP)
  - EP** = Electric Rewind (1/2 HP) – 12v and 24v DC rewind reels supplied with switch and solenoid. 115v AC rewind reels are not supplied with switch, but can be ordered separately.
  - HD** = Hydraulic Rewind – not supplied with control valve.
- For polished aluminum reels, prefix complete model number with "SB" (for example: SBESF32-19-21).
- All frames are rollformed channel, except Super Booster®, which is square tubing.
- Be sure to check dimensions and weights prior to ordering.**

**NOTICE:** A flexible connector must be used between the inlet pipe and the inlet swivel joint.

\* Reels handling 175' or more of 1" must use 1/2 HP motor.

\*\*\* X, Y indicate mounting holes.

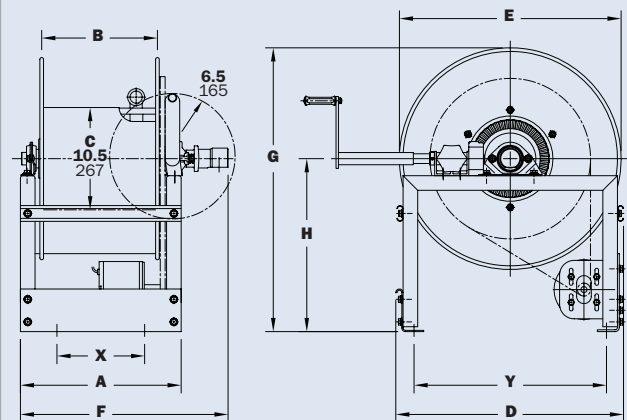

# Series **FF/SBFF**

• Large Diameter Booster Hose • Preconnected Collapsible Hose

**To handle 1-1/4" or 1-1/2" I.D. booster hose or 1-1/2" or 1-3/4" I.D. collapsible hose.**

- Standard booster hose reel is steel, painted graphite. Aluminum or stainless steel construction is also available.
- Super Booster (SBFF) polished aluminum construction reel weighs up to 30% less than standard booster reel. Prefix complete model number with "SB" when ordering. See Note 6 on page 11.
- Gear-driven crank rewind is standard. Choose chain and sprocket drive powered by electric, hydraulic or compressed air motor.
- Pinion brake standard.
- Standard inlet: 1-1/2" 90° ball bearing swivel joint with 1-1/2" female NPT threads and 2" Victaulic® groove.
- Standard outlet: 1-1/2" male NST threads. (1.990" x 9 threads per inch.)
- Consult factory for other sizes and/or threads.
- Standard inlet, outlet riser, and hub assembly are steel (also available in stainless steel).
- Rollers and roller mounting brackets are accessory items. Specify roller position.
- Standard pressures to 600 psi (41 bar).
- Standard fluid temperatures from -20° F to +212 °F (-29° C to +100° C).
- Consult factory for other pressures and temperatures.



Standard configuration shown with Electric Rewind (EP) and optional polished aluminum construction

**CAUTION:** When using Niedner|Altra® hose, a special riser and/or larger drum diameter is required.

See chart for capacity on page 18, or consult factory.

**Optional**

## Twin Fire Reel **Conversion Kit** | For Booster Hose

**For Series F and FF.**

Twin booster hose reels combine matched F or FF Series reels in a single unit with a center-mounted roller and spool assembly. Hose from both reels can be used on either side of the truck. Rugged unit frame construction maintains alignment and simplifies installation when two reels are combined.

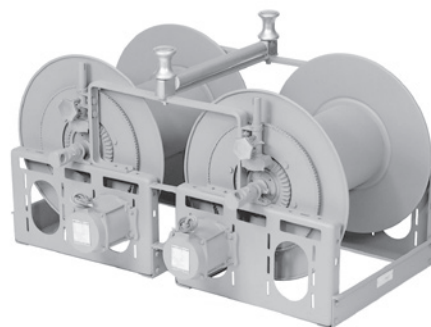

Two F Series reels, and a standard Twin Fire Reel Conversion Kit

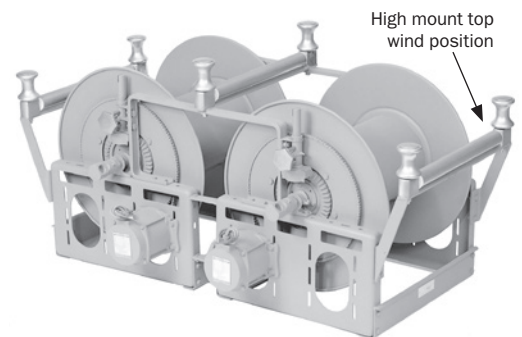

Two F Series reels, a Twin Fire Reel Conversion Kit, and two optional outrigger roller assemblies

**Consult dealer or factory for more information.**

# Series FF/SBFF

• Large Diameter Booster Hose • Preconnected Collapsible Hose

## PARTS DRAWING – ISO 18 PRESSED FRAME, OR ISO 41 ROLLFORM FRAME

Model Number	Hose Capacity of Reel feet m					Approx. Weight Crank Rewind lb. kg see Note 4				Reel Dimensions*** in. mm								
	Round Hose			Collapsible Hose		STEEL		ALUMINUM see Note 6		A	B	D	E	F	G	H	X	Y
	I.D. in. mm	1-1/4 32	1-1/2 38	1-1/2 38	1-3/4 44	NET	SHIP	NET	SHIP									
	O.D. in. mm	1-13/16 46	2-1/16 52	3/4 x 3 19 x 76	7/8 x 3-1/4 22 x 83													
FF28-23-24	100	50	150	125	111	153	86	128	25.5	20	20.5	23	32.25	23.5	12.12	17.5	16.75	
	30	15	46	38	50	69	39	58	648	508	521	584	819	579	308	445	425	
FF28-25-26	100	100	200	175	123	165	96	138	25.5	20	25.5	24.75	32.25	27.88	15.5	17.5	21.75	
	30	30	61	53	56	75	43	62	648	508	648	629	819	708	394	445	552	
FF16-30-31	75	50	100	75	110	160	86	136	13	7.5	25.5	28.75	19.75	29.88	15.5	7.75	21.75	
	23	15	30	23	50	73	39	62	330	191	648	730	502	759	394	197	552	
FF18-30-31	100	75	150	75	114	164	89	139	15	9.5	25.5	28.75	21.75	29.88	15.5	7	21.75	
	30	23	46	23	52	74	40	63	381	241	648	730	552	759	394	178	552	
FF28-30-31	250	150	300	250	131	181	99	149	25.5	20	25.5	28.75	32.25	29.88	15.5	17.5	21.75	
	76	46	91	76	59	82	45	67	648	508	648	730	819	759	394	445	552	
FF20-33-34	125	100	200	150	120	174	92	146	16.5	11.5	31.5	31.75	23.25	33.62	17.75	9	27.75	
	38	30	61	46	54	79	42	66	419	292	800	806	591	854	451	229	705	
FF22-33-34	150	150	250	200	125	179	95	149	18.5	13.5	31.5	31.75	25.25	33.62	17.75	11	27.75	
	46	46	76	61	57	81	43	67	470	343	800	806	641	854	451	279	705	

**Notes:**

- Specifications subject to change.
- Dimensions up to and including 30-31 disc size reflect pressed frames. All others are rollformed channel frames, except Super Booster®, which is square tubing.
- Upon request, reels can be supplied with drum lengths other than shown and with disc sizes in other diameters.
- Weights shown in chart are for crank rewind models. ADD these amounts for power rewind models.
 

	Net lbs/kg	Ship lbs/kg
Electric	40/18.1	40/18.1
Hydraulic	20/9.1	20/9.1
Air	20/9.1	20/9.1
- When ordering power rewind models, prefix model number with:
  - A** = Air Rewind – supplied with control valve and 18" air hose.
  - EP** = Electric Rewind (1/2 HP) – 12v and 24v DC rewind reels supplied with switch and solenoid. 115v AC rewind reels are not supplied with switch, but can be ordered separately.
  - HD** = Hydraulic Rewind – not supplied with control valve.
- For polished aluminum reels, prefix complete model number with "SB" (for example: SBEPFF28-23-24).
- Be sure to check dimensions and weights prior to ordering.**

**NOTICE:** A flexible connector must be used between the inlet pipe and the inlet swivel joint.

\*\*\* X, Y indicate mounting holes.

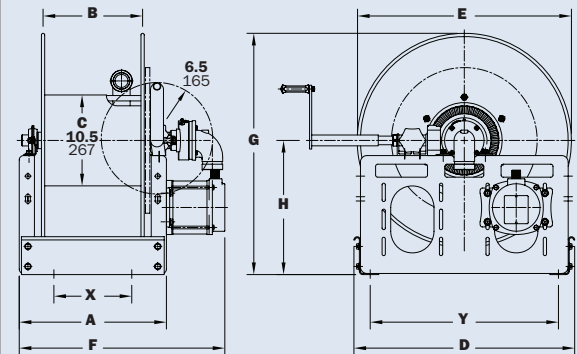



## Series **F7100** | Dual Hose

### • Dual Agent Applications

#### To handle dual 3/4" through 1" I.D. hose.

- Two swivel joint inlets and two outlet risers.
- All models are available with optional aluminum or stainless steel construction.
- Super Booster (SB) polished aluminum construction reel weighs up to 30% less than standard booster reel. Prefix complete model number with "SB" when ordering. See Note 5 on page 13.
- Gear-driven crank rewind is standard. Choose chain and sprocket drive powered by electric, hydraulic or compressed air motor.
- Pinion brake standard.
- Standard inlets: 1" 90° ball bearing swivel joint, 1" female NPT threads.
- Standard outlets: 1" male NST threads (1.375" x 8 threads per inch).
- Standard inlet, outlet riser, and hub assembly are steel (also available in stainless steel).
- Consult factory for other sizes and/or threads.
- Standard pressures to 1000 psi (69 bar).
- Standard fluid temperatures from -15° F to +250 °F (-26° C to +121° C).
- Consult factory for other pressures and temperatures.
- Rollers and roller mounting brackets are accessory items. Specify roller position.

**CAUTION:** When using Niedner|Altra® hose, a special riser and/or larger drum diameter is required (consult factory). See page 18.



#### **SBEPF7100 Series**

Standard configuration shown with optional aluminum construction (SB) and Electric Rewind (EP)



#### **SBEPF7100 Series shown**

Standard configuration shown with optional aluminum construction (SB), Electric Rewind (EP) and roller and spool assembly high mount

### PARTS DRAWING-F7100 - ISO 72

Model Number	Hose Capacity of Reel feet m			Approx. Weight Crank Rewind lb. kg see Note 3		Reel Dimensions*** in. mm									
	I.D. in. mm	3/4 19	1 25	NET	SHIP	A	B	D	E	F CRANK	F POWER	G	H	X	Y
	O.D. in. mm	1-9/32 33	1-1/2 38												
<b>F7126-23-24</b>	<b>2/75</b>	<b>2/50</b>	<b>109</b>	<b>151</b>	<b>23</b>	<b>17.5</b>	<b>20.5</b>	<b>23</b>	<b>32.5</b>	<b>34.5</b>	<b>23.5</b>	<b>12.12</b>	<b>15</b>	<b>16.75</b>	
	2/23	2/15	49	68	584	445	521	584	826	876	597	308	381	425	
<b>F7130-25-26</b>	<b>2/125</b>	<b>2/100</b>	<b>125</b>	<b>175</b>	<b>27.5</b>	<b>22</b>	<b>25.5</b>	<b>24.75</b>	<b>37</b>	<b>39</b>	<b>27.88</b>	<b>15.5</b>	<b>19.5</b>	<b>21.75</b>	
	2/38	2/31	57	79	699	559	648	629	940	991	708	394	495	552	
<b>F7130-30-31</b>	<b>2/200</b>	<b>2/150</b>	<b>129</b>	<b>179</b>	<b>27.5</b>	<b>22</b>	<b>25.5</b>	<b>28.75</b>	<b>37</b>	<b>39</b>	<b>29.88</b>	<b>15.5</b>	<b>19.5</b>	<b>21.75</b>	
	2/61	2/46	59	81	699	559	648	730	940	991	759	394	495	552	
<b>F7132-33-34</b>	-	<b>2/200</b>	<b>129</b>	<b>179</b>	<b>29</b>	<b>24</b>	<b>31.5</b>	<b>31.75</b>	<b>38.5</b>	<b>40.5</b>	<b>33.62</b>	<b>17.75</b>	<b>21.5</b>	<b>27.75</b>	
	-	2/61	59	81	737	610	800	806	978	1029	854	451	546	705	

#### Notes:

- Specifications subject to change.
- Upon request, reels can be supplied with drum lengths other than shown and with disc sizes in other diameters.
- Weights shown in chart are for crank rewind models. ADD these amounts for power rewind models:

	Net lbs/kg	Ship lbs/kg
<b>Electric</b>	<b>40/18.1</b>	<b>40/18.1</b>
<b>Hydraulic</b>	<b>20/9.1</b>	<b>20/9.1</b>
<b>Air</b>	<b>20/9.1</b>	<b>20/9.1</b>

- When ordering power rewind models, prefix model number with:
  - A** = Air Rewind – supplied with control valve and 18" air hose.
  - EP** = Electric Rewind (1/2 HP) – 12v and 24v DC rewind reels supplied with switch and solenoid. 115v AC rewind reels are not supplied with switch, but can be ordered separately.
  - HD** = Hydraulic Rewind – not supplied with control valve.

- For polished aluminum reels, prefix complete model number with "SB" (for example: SBEPF7126-23-24).
- Be sure to check dimensions and weights prior to ordering.**

**NOTICE:** A flexible connector must be used between the inlet pipe and the inlet swivel joint.

\*\*\* X, Y indicate mounting holes.

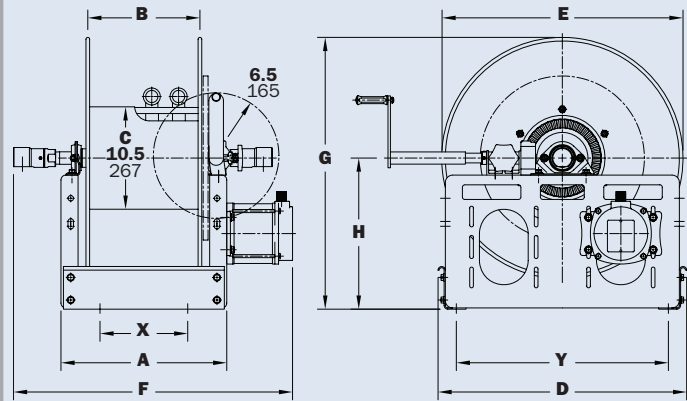

## Series **F3100/FF3600**

### • Industrial Fire Protection

#### To handle 3/4" through 1-1/2" I.D. booster hose or 1" through 1-3/4" I.D. collapsible hose.

- The reel can be installed on the floor or wall.
- Steel construction is standard. Aluminum or stainless steel construction is available.
- Choose disc rewind or removable direct crank rewind.
- Supplied with spring actuated pin lock.
- Standard inlet, outlet riser, and hub assembly are steel (also available in stainless steel).
- Rollers and roller mounting brackets are accessory items. Specify roller position.

#### Series **F3100**

- Standard inlet: 1" 90° ball bearing swivel joint with 1" female NPT threads.
- Standard outlet: 1" male NST threads (1.375" x 8 threads per inch).
- Standard pressures to 1000 psi (69 bar).
- Standard fluid temperatures from -15° F to +250 °F (-26° C to +121° C)

#### Series **FF3600**

- Standard inlet: 1-1/2" 90° ball bearing swivel joint with 1-1/2" female NPT threads and 2" Victaulic® groove.
- Standard outlet: 1-1/2" male NST threads (1.990" x 9 threads per inch).
- Standard pressures to 600 psi (41 bar).
- Standard fluid temperatures from -20° F to +212 °F (-29° C to +100° C).

#### Both Series

- Consult factory for other sizes and/or threads.
- Consult factory for other pressures and temperatures.
- Removable crank rewind is standard.
- For hand over hand rewind option (less crank), consult factory.

**CAUTION:** When using Niedner|Altra® hose, a special riser and/or larger drum diameter is required (consult factory). See page 18.

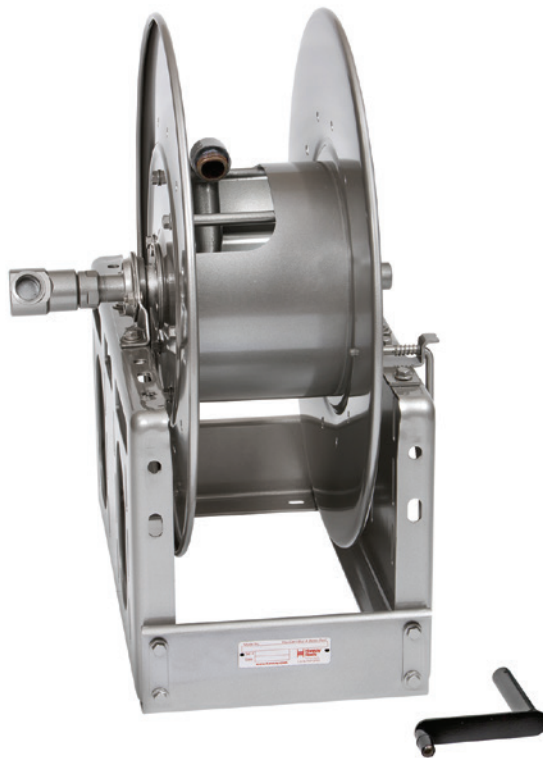

**F3100 Series**  
Standard configuration shown



**FF3600 Series**  
Standard configuration shown



# Series F3100/FF3600

• Industrial Fire Protection

## PARTS DRAWING – F3100 – ISO 113; FF3600 – ISO 111

Model Number	Hose Capacity of Reel feet m				Approx. Weight Crank Rewind lb. kg		Reel Dimensions*** in. mm						
	Round Hose		Collapsible Hose		NET	SHIP	A	B	E	F	G	H	X
	I.D. in. mm	3/4 19	1 25	1 26									
	O.D. in. mm	1-9/32 33	1-1/2 38	1/2 x 1-3/4 13 x 44									
<b>F3116-25-26</b>	<b>100</b> 30	<b>75</b> 23	<b>200</b> 61	<b>85</b> 39	<b>120</b> 54	<b>13</b> 330	<b>7.5</b> 191	<b>24.75</b> 629	<b>25.5</b> 648	<b>27.88</b> 708	<b>15.5</b> 394	<b>7.75</b> 197	
<b>F3120-25-26</b>	<b>150</b> 46	<b>100</b> 30	<b>350</b> 107	<b>94</b> 43	<b>129</b> 59	<b>17</b> 432	<b>11.5</b> 292	<b>24.75</b> 629	<b>29.5</b> 749	<b>27.88</b> 708	<b>15.5</b> 394	<b>9</b> 229	
<b>F3124-25-26</b>	<b>200</b> 61	<b>125</b> 38	<b>450</b> 137	<b>103</b> 47	<b>138</b> 63	<b>21</b> 533	<b>15.5</b> 394	<b>24.75</b> 629	<b>33.5</b> 851	<b>27.88</b> 708	<b>15.5</b> 394	<b>13</b> 330	
<b>F3128-25-26</b>	<b>275</b> 84	<b>175</b> 53	<b>650</b> 198	<b>113</b> 51	<b>155</b> 70	<b>25.5</b> 648	<b>20</b> 508	<b>24.75</b> 629	<b>37</b> 940	<b>27.88</b> 708	<b>15.5</b> 394	<b>17.5</b> 445	
<b>F3124-30-31</b>	<b>350</b> 107	<b>250</b> 76	–	<b>103</b> 47	<b>153</b> 70	<b>21</b> 533	<b>15.5</b> 394	<b>28.75</b> 730	<b>33.5</b> 851	<b>29.88</b> 759	<b>15.5</b> 394	<b>13</b> 330	
<b>F3130-30-31</b>	–	<b>300</b> 91	–	<b>113</b> 51	<b>143</b> 65	<b>27.5</b> 699	<b>22</b> 559	<b>28.75</b> 730	<b>40</b> 1016	<b>29.88</b> 759	<b>15.5</b> 394	<b>19.5</b> 495	

Model Number	Hose Capacity of Reel feet m				Approx. Weight Crank Rewind lb. kg		Reel Dimensions*** in. mm								
	Round Hose		Collapsible Hose		NET	SHIP	A	B	D	E	F	G	H	X	Y
	I.D. in. mm	1-1/2 38	1-1/2 38	1-3/4 44											
	O.D. in. mm	2-1/16 52	3/4 x 3 19 x 76	7/8 x 3-1/4 22 x 83											
<b>FF3620-25-26</b>	<b>50</b> 15	<b>150</b> 46	<b>75</b> 23	<b>104</b> 47	<b>139</b> 63	<b>17</b> 432	<b>11.5</b> 292	<b>25.5</b> 648	<b>24.75</b> 629	<b>30.75</b> 781	<b>27.88</b> 708	<b>15.5</b> 394	<b>9</b> 229	<b>21.75</b> 552	
<b>FF3624-25-26</b>	<b>75</b> 23	<b>150</b> 46	<b>100</b> 30	<b>113</b> 51	<b>148</b> 67	<b>21</b> 533	<b>15.5</b> 394	<b>25.5</b> 648	<b>24.75</b> 629	<b>34.75</b> 883	<b>27.88</b> 708	<b>15.5</b> 394	<b>13</b> 330	<b>21.75</b> 552	
<b>FF3628-25-26</b>	<b>100</b> 30	<b>200</b> 61	<b>150</b> 46	<b>123</b> 56	<b>173</b> 78	<b>25.5</b> 648	<b>20</b> 508	<b>25.5</b> 648	<b>24.75</b> 629	<b>39.25</b> 997	<b>27.88</b> 708	<b>15.5</b> 394	<b>17.5</b> 445	<b>21.75</b> 552	
<b>FF3624-30-31</b>	<b>100</b> 30	<b>250</b> 76	<b>150</b> 46	<b>124</b> 56	<b>174</b> 79	<b>21</b> 533	<b>15.5</b> 394	<b>25.5</b> 648	<b>28.75</b> 730	<b>34.75</b> 883	<b>30.38</b> 772	<b>15.5</b> 394	<b>13</b> 330	<b>21.75</b> 552	
<b>FF3628-30-31</b>	<b>150</b> 46	<b>300</b> 91	<b>250</b> 76	<b>134</b> 61	<b>184</b> 83	<b>25.5</b> 648	<b>20</b> 508	<b>25.5</b> 648	<b>28.75</b> 730	<b>39.25</b> 997	<b>30.38</b> 772	<b>15.5</b> 394	<b>17.5</b> 445	<b>21.75</b> 552	
<b>FF3634-30-31</b>	<b>200</b> 61	<b>400</b> 122	<b>350</b> 107	<b>147</b> 67	<b>197</b> 89	<b>31.5</b> 800	<b>26</b> 660	<b>25.5</b> 648	<b>28.75</b> 730	<b>45.25</b> 1149	<b>30.38</b> 772	<b>15.5</b> 394	<b>23.5</b> 597	<b>21.75</b> 552	
<b>FF3630-33-34</b>	<b>250</b> 76	<b>450</b> 137	<b>350</b> 107	<b>138</b> 63	<b>188</b> 85	<b>27</b> 686	<b>22</b> 559	<b>31.5</b> 800	<b>31.75</b> 806	<b>41.25</b> 1048	<b>32.38</b> 822	<b>16.5</b> 419	<b>19.5</b> 495	<b>27.75</b> 705	

**Notes:**

- Specifications subject to change.
- Upon request, reels can be supplied with drum lengths other than shown and with disc sizes in other diameters.
- Power rewind is not available on these models. See Series F or FF.
- 4" clearance needed for crank handle removal.
- Be sure to check dimensions and weights prior to ordering.**

**NOTICE:** A flexible connector must be used between the inlet pipe and the inlet swivel joint.

\*\*\*X, Y indicate mounting holes.

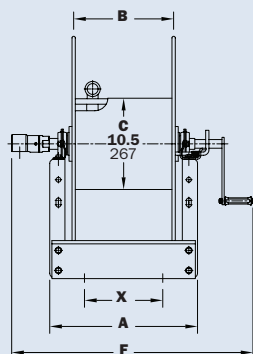

F3100

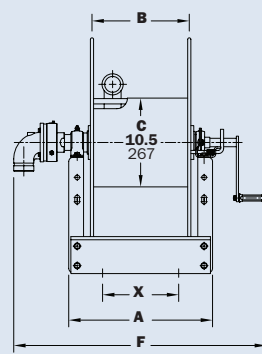
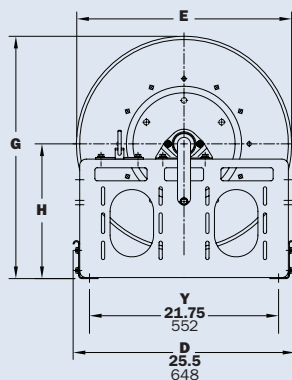

FF3600

# Series LD Reels and Spools | Large Diameter

**Reels and spools to handle up to 6" I.D. collapsible hose.**

**Typical Installations:**

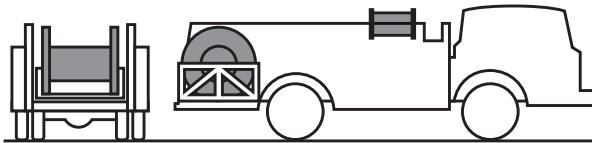

Single large-capacity reel installed in the hose bed area to handle long lengths of pre-coupled hose. Hose pays out from the top of the reel so gravity assists unwinding.

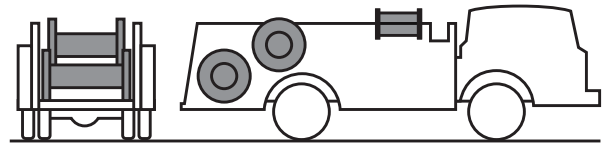

Two reels installed in the hose bed. In this arrangement, the upper reel is unloaded only if necessary. Payout and rewinding of the upper reels are facilitated by the position of the lower reel. Two reels with larger-diameter discs and narrower drums can also be installed side-by-side in the rear of the hose bed to handle approximately the same amount of hose. This method allows a center walkway or paying out two lines simultaneously if required.

- Square tubing frames.
- Heavy-gauge steel discs.
- Drums are formed by reinforced tie rods with radial supports.
- Pillow block ball bearings.
- Chain and sprocket rewind with electric (12v or 24v) or hydraulic rewind motor.
- Hydraulic caliper disc brake.

**Hydraulic Requirements**

- It is important that the end-user provide Hannay Reels with complete specifications as to the required operation of the large diameter reel being specified. Any speed and torque requirements **MUST** be known to properly specify the correct reel for the application.
- Hannay Reels does not recommend specific brands for hydraulic system components. We suggest you work with your hydraulic component supplier to meet your specs.

**Custom Reels**

- The standard models listed represent the most frequently specified customer requirements for handling large-diameter fire hose. Because of the many possible variations in reel installation and hose capacity requirements, we will also custom build reels and spools to your specifications to become an integral part of the apparatus. Reels are built of steel construction, and various finishes are available.

**Consult factory for complete specifications on an LD reel to meet your requirements.**

**Important:** Hose capacity is based on the flat hose dimensions listed below, with couplings at 100 foot intervals.

**Flat Hose Dimensions**

I.D.	Thick x Width	
	in	mm
1"	1/2 x 1-3/4	12.7 x 44.4
1-1/2"	3/4 x 3	19.0 x 76.2
1-3/4"	7/8 x 3-1/4	22.2 x 79.4
2"	3/4 x 3-1/2	19.0 x 88.9
2-1/2"	3/4 x 4	19.0 x 101.6
3"	1/2 x 5	12.7 x 127.0
4"	1/2 x 6-1/2	12.7 x 165.1
5"	1/2 x 8	12.7 x 203.2
6"	1/2 x 10	12.7 x 254.0

*Custom sizes are available to meet specific needs.*

Large Diameter

# Series LD Reels and Spools

Configurations

PARTS DRAWING – ISO 104

Model Number	Hose Capacity of Reel feet m										Approx. Weight (Steel) Crank Rewind lb. kg		Reel Dimensions in. mm						
	I.D. in.	1-1/2	1-3/4	2	2-1/2	3	4	5	6	NET	SHIP	A	A	B	D	E	G	H	
	mm	38	44	51	64	76	102	127	152			HYD REWIND	ELECT REWIND						
LD268-30	800	600	600	600	600	600	500	250	-	370	450	65.5	63	54	30.5	30	39	24	
	244	183	183	183	183	183	152	76	-	168	204	1664	1600	1372	775	762	991	610	
LD268-33	1000	700	800	700	800	600	350	-	-	385	465	65.5	63	54	33.5	33	42	25.5	
	305	213	244	213	244	183	107	-	-	175	211	1664	1600	1372	851	838	1067	648	
LD234-39	-	400	350	350	400	300	200	-	-	365	465	31.5	29	20	39.5	39	45	25.5	
	-	122	107	107	122	91	61	-	-	166	211	800	737	508	1003	991	1143	648	
LD242-39	-	500	600	500	500	400	300	-	-	381	481	39.5	37	28	39.5	39	45	25.5	
	-	152	183	152	152	122	91	-	-	173	218	1003	940	711	1003	991	1143	648	
LD262-39	-	-	-	-	-	1100	800	600	-	421	521	59.5	57	48	39.5	39	45	25.5	
	-	-	-	-	-	335	244	183	-	191	236	1511	1448	1219	1003	991	1143	648	
LD274-39	-	-	-	-	-	-	1050	800	-	445	545	71.5	69	60	39.5	39	45	25.5	
	-	-	-	-	-	-	320	244	-	202	247	1816	1753	1524	1003	991	1143	648	
LD242-45	-	-	-	-	-	-	500	400	-	427	557	40	-	28	45.5	45	51	28.5	
	-	-	-	-	-	-	152	122	-	194	253	1016	-	711	1156	1143	1295	724	
LD262-45	-	-	-	-	-	-	1100	900	-	467	597	60	-	48	45.5	45	51	28.5	
	-	-	-	-	-	-	335	274	-	212	271	1524	-	1219	1156	1143	1295	724	
LD274-45	-	-	-	-	-	-	1400	1100	-	491	621	72	-	60	45.5	45	51	28.5	
	-	-	-	-	-	-	427	335	-	223	282	1829	-	1524	1156	1143	1295	724	
LD242-52	-	-	-	-	-	-	800	500	300	581	731	40	-	28	52.5	52	58	32	
	-	-	-	-	-	-	244	152	91	264	332	1016	-	711	1334	1321	1473	813	
LD262-52	-	-	-	-	-	-	1500	1300	800	621	771	60	-	48	52.5	52	58	32	
	-	-	-	-	-	-	457	396	244	282	350	1524	-	1219	1334	1321	1473	813	
LD274-52	-	-	-	-	-	-	2000	1500	1200	645	795	72	-	60	52.5	52	58	32	
	-	-	-	-	-	-	610	457	366	283	361	1829	-	1524	1334	1321	1473	813	
LD250-56	-	-	-	-	-	-	1300	1000	700	657	817	48	-	36	56.5	56	62	34	
	-	-	-	-	-	-	396	305	213	298	371	1219	-	914	1435	1422	1575	864	
LD262-56	-	-	-	-	-	-	1800	1500	900	681	841	60	-	48	56.5	56	62	34	
	-	-	-	-	-	-	549	457	274	309	381	1524	-	1219	1435	1422	1575	864	
LD274-56	-	-	-	-	-	-	2300	1700	1400	705	865	72	-	60	56.5	56	62	34	
	-	-	-	-	-	-	701	518	427	320	392	1829	-	1524	1435	1422	1575	864	
LD350-64	-	-	-	-	-	-	1700	1300	900	1130	1330	50.25	-	36	64.75	64	70	38	
	-	-	-	-	-	-	518	396	274	513	603	1276	-	914	1645	1626	1778	965	
LD374-64	-	-	-	-	-	-	3000	2000	1900	1200	1400	74.25	-	60	64.75	64	70	38	
	-	-	-	-	-	-	914	610	579	544	635	1886	-	1524	1645	1626	1778	965	

Electric rewind not available on these models

**Version F Reel:**

Complete reel assembly with No. 50 chain and sprocket and hydraulic rewind motor mounted inside the frame. When ordering, prefix model number with HD (for example: HDLD 350-64 version F).

**Version H Reel:**

Complete reel assembly with chain and sprocket drive and electric rewind motor, including electric clutch and double reduction unit. Motor is mounted outside the frame. Disc diameters (E dimension) up to and including 39" only. When ordering, prefix model number with EP (for example: EPLD 242-39 version H). "F" dimension = "A" dimension + 7".

**Notes:**

1. Specifications subject to change.
2. Upon request, reels can be supplied with drum lengths other than shown and with disc sizes in other diameters.
3. Be sure to check dimensions and weights prior to ordering.

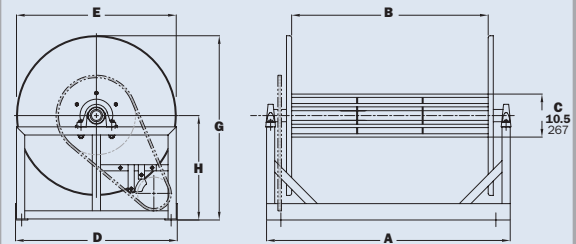

VERSION F

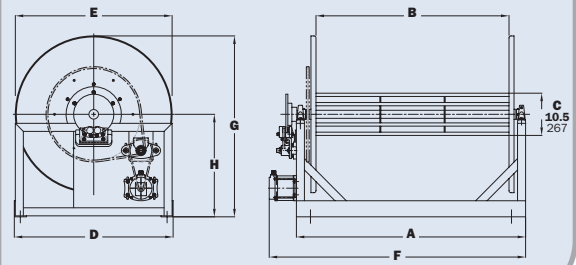

VERSION H



# Mercedes and Niedner |Altra® Capacities

## Mercedes Hose

Reel Model Number	Hose Capacity of Reel feet m				Approx. Weight lb. kg				Reel Dimensions*** in. mm									
	I.D. in. mm	3/4 19	1 25	1-1/2 38	STEEL		ALUMINUM		A	B	C	D	E	F POWER	G	H	X	Y
	O.D. in. mm	1.062 27	1.281 33	1.812 46	NET	SHIP	NET	SHIP										
F4024-17-18	100	-	-	-	46	81	-	-	21	16	8	14.5	19	27	18.12	9.88	19.5	10
	30	-	-	-	21	37	-	-	533	406	203	368	483	686	460	251	495	254
F4030-17-18	200	-	-	-	57	92	-	-	27	22	8	14.5	19	33	18.12	9.88	25.5	10
	61	-	-	-	26	42	-	-	686	559	203	368	483	838	460	251	648	254
F4124-17-18	100	-	-	-	72	107	-	-	21	16	8	15.5	20.5	27.5	18.12	9.88	13.5	12.25
	30	-	-	-	33	49	-	-	533	406	203	394	521	699	460	251	343	311
F4130-17-18	200	-	-	-	83	118	-	-	27	22	8	15.5	20.5	33.5	18.12	9.88	19.5	12.25
	61	-	-	-	38	54	-	-	686	559	203	394	521	851	460	251	495	311
*F32-19-21	175	150	-	-	102	144	80	122	29.5	24	10.5	20.5	21.62	34.38	21.5	12.12	21.5	16.75
	53	46	-	-	46	65	36	55	749	610	267	521	549	873	546	308	546	425
*F24-23-24	200	150	-	-	92	134	75	117	21	15.5	10.5	20.5	23	25.88	23.5	12.12	13	16.75
	61	46	-	-	42	61	34	53	533	394	267	521	584	657	597	308	330	425
*F30-23-24	300	200	-	-	105	147	82	124	27.5	22	10.5	20.5	23	32.38	23.5	12.12	19.5	16.75
	91	61	-	-	48	67	37	56	699	559	267	521	584	822	597	308	495	425
*F16.5-30-31	200	150	-	-	100	150	80	130	13.5	8	10.5	25.5	28.75	18.38	29.88	15.5	5.5	21.75
	61	46	-	-	45	68	36	59	343	203	267	648	730	467	759	394	140	552
*F20-30-31	300	200	-	-	107	157	83	133	17	11.5	10.5	25.5	28.75	21.88	29.88	15.5	9	21.75
	91	61	-	-	49	71	38	60	432	292	267	648	730	556	759	394	229	552
FF32-30-31-20	-	-	100	-	138	188	100	150	29.5	24	20	25.5	28.75	36.25	29.88	15.5	21.5	21.75
	-	-	30	-	63	54	45	68	749	610	508	648	730	921	759	394	546	552
FF34-33-34-20	-	-	200	-	140	194	106	160	31	26	20	31.5	31.75	37.75	33.62	17.75	23.5	27.75
	-	-	61	-	64	88	48	73	787	660	508	800	806	959	854	451	597	705

## Niedner|Altra® Hose

Reel Model Number	Hose Capacity of Reel feet m				Approx. Weight lb. kg				Reel Dimensions*** in. mm									
	I.D. in. mm	3/4 19	1 25	1-1/2 38	STEEL		ALUMINUM		A	B	C	D	E	F POWER	G	H	X	Y
	O.D. in. mm	1.075 27	1.325 34	1.825 46	NET	SHIP	NET	SHIP										
*F28-19-21-10.5	100	-	-	-	98	140	76	118	25.5	20	10.5	20.5	21.62	30.25	21.5	12.12	17.5	16.75
	30	-	-	-	44	64	34	54	648	508	267	521	549	768	546	308	445	425
*F26-23-24-10.5	200	-	-	-	94	136	71	113	23	17.5	10.5	20.5	23	27.88	23.5	12.12	15	16.75
	61	-	-	-	43	62	32	51	584	445	267	521	584	708	597	308	381	425
*F24-23-24-12	-	100	-	-	92	134	75	117	21	15.5	12	20.5	23	25.88	23.5	12.12	13	16.75
	-	30	-	-	42	61	34	53	533	394	305	521	584	657	597	308	330	425
F28-25-26-12	-	200	-	-	113	155	87	129	25.5	20	12	25.5	24.75	32.25	27.88	15.5	17.5	21.75
	-	61	-	-	51	70	39	59	648	508	305	648	629	819	708	394	445	552
FF32-30-31-20	-	-	100	-	138	188	100	150	29.5	24	20	25.5	28.75	36.25	29.88	15.5	21.5	21.75
	-	-	30	-	63	54	45	68	749	610	508	648	730	921	759	394	546	552
FF34-33-34-20	-	-	200	-	140	194	106	160	31	26	20	31.5	31.75	37.75	33.62	17.75	23.5	27.75
	-	-	61	-	64	88	48	73	787	660	508	800	806	959	854	451	597	705

**Notes:**

1. Specifications subject to change.
2. These reels require a special angle riser and larger diameter drum; consult factory.
3. For F Series – Refer to notes and diagram on page 7.
4. For FF Series – Refer to notes and diagram on page 11.

**NOTICE:** A flexible connector must be used between the inlet pipe and the inlet swivel joint.  
 \*The "F" dimension for these models is shown for 1/3 HP motors. Add 2" to "F" dimension for 1/2 HP motors. The "F" dimension for all other reels is shown for 1/2 HP. Reels handling 200' or more must use 1/2 HP motor. (Use prefix EP when ordering.)

\*\*\* X, Y indicate mounting holes.

# Hannay Reels **Sales Policies**

## **Hannay Reels 3-Year Limited Warranty**

Products manufactured by Hannay Reels, Inc. (“Hannay”) are warranted for 3 years from date of shipment when properly installed, maintained, and operated in accordance with Hannay instructions. In no event will Hannay have a warranty obligation for normal wear and tear, or for products that have, at Hannay’s determination, been subjected to accident, abuse, misapplication, improper installation or improper maintenance. Common examples of normal wear and tear would include paint finish, swivel joint seal wear, and switch or motor brush wear.

Hannay makes no warranties, express or implied, other than those included in this warranty statement, and we disclaim any implied warrant of merchantability or fitness for any particular purpose. Hannay will not be liable for any consequential, incidental, or indirect damages from any cause whatsoever.

Failure to use a flexible inlet connection on any live hose reel will void the swivel joint warranty. Failure to use a properly sized circuit breaker with any electric rewind motor will void the electric motor warranty. Failure to use a filter and lubricator on any air rewind motor will void the air motor warranty. Failure to follow all procedures outlined in the Safety Guidelines document will void the warranty.

Components not manufactured by Hannay will be subject to the original manufacturers’ warranties. Examples of such components include: hose and cable, motors, speed controls, and switches, swivel joints and seals, slip ring and brush assemblies.

Equipment which proves to be defective upon our inspection will be replaced free of charge, including freight to the customer. Our responsibility ceases upon delivery to any common carrier and we do not, unless previously instructed, insure shipments beyond point of delivery to such carrier. **No material will be accepted for return without a return goods authorization (RGA).** This warranty extends to the replacement or repair of the reel or part (no labor).

Hannay reserves the right to modify or alter materials, dimensions, design, and construction when necessary to improve the performance of the reel and/or accessories, or to meet delivery requirements.

## **Notice on Reel Finish**

Standard finish on Hannay reels is a high performance enamel paint. Standard color is metallic graphite. Other colors available, please consult factory.

Most of the major components on standard reels are e-coated prior to receiving final topcoat paint finish. This combination of e-coat and enamel topcoat will meet the finish requirements of most customer applications and environments.

In cases where requirements cannot be met with the standard finish, Hannay Reels can coat any model reel with an automotive primer, allowing application of final coating at your facility.

Alternatively, Hannay Reels can provide a quote for matching a customer-provided paint specification. For further information, please contact your Hannay Reels sales engineer and a special paint request form will be sent to you.

For environments where no paint finish is suitable, we offer both aluminum and stainless steel (304 grade) construction on most reel models.

## **Return Goods Policy**

All Hannay reels are built to order. These orders are typically placed into production within 1 business day of receipt. Once production begins, it may not be possible to cancel the order.

To prevent returns because the wrong reels or parts were ordered, please use the Hannay Reels Spec Worksheet (either online or from our Ordering & Accessory Guide) when specifying reels. Be sure to include any size, weight, pressure and/or material compatibility limitations for the application.

**In the event that an item does need to be returned for credit, repair or replacement, prior approval must be obtained from Hannay Reels.** Upon your request, we will send a Return Goods

Authorization (RGA) form. A signed copy of this form must accompany the material when returned to us, with the RGA number clearly showing on the outside of the box—a label is provided to you that you can print and attach. No product will be accepted for return or credit without an authorized RGA number.

All material must be returned prepaid, unless otherwise noted on our RGA. No return will be accepted that has been damaged due to improper return packaging, tampered with or altered from its original condition. Our restocking and handling fee is a minimum of 25% for standard catalog reels and parts. Custom reels specially built to customer specifications cannot be returned for any reason.

# Find reels for every need.

Learn more about all of our reels, including specs, drawings, and even how to select the right reels and accessories for your industry.

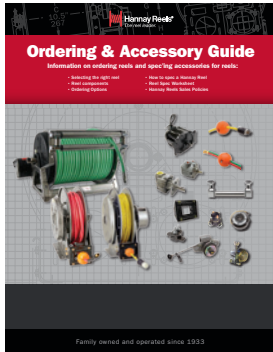

## Ordering & Accessory Guide

- Selecting the right reel
- Reel components
- Available accessories
- How to spec and order reels and accessories
- Ordering options
- Hannay Reels policies

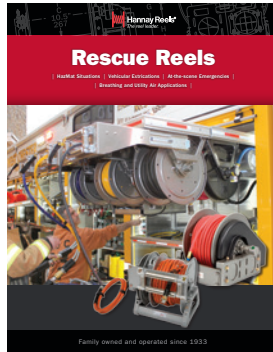

## Rescue Reels

- Utility or breathing air hose reels
- Hazmat reels
- Live electric cable reels
- Power rescue tool reels
- Portable electric cable reels

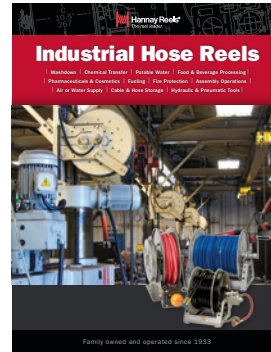

## Industrial Hose Reels

- High pressure/low pressure reels
- Air/Lube/Grease reels
- Fueling
- Washdown/Power Wash
- Industrial Fire Protection
- Hydraulic/Pneumatic applications
- Hose Storage

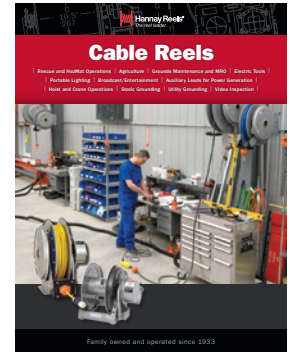

## Cable Reels

- Electric Tools
- Crane operations
- Portable Lighting
- Live and storage reels
- Video/Broadcast
- Static and Utility grounding reels

View all our reel catalogs online at [hannay.com](http://hannay.com)



Family owned and operated since 1933, Hannay Reels is the world leader in both OEM and aftermarket applications. Hannay offers thousands of standard hose reel and cable reel models, as well as unmatched custom capabilities. We can easily and affordably customize a reel to meet your exact specifications – built to last, delivered fast. Additional catalogs are available through your local Hannay Reels dealer or online at [hannay.com](http://hannay.com).



553 State Route 143 | Westerlo, New York 12193  
Email: [reels@hannay.com](mailto:reels@hannay.com) | [hannay.com](http://hannay.com)



All Hannay reels are constructed of quality heavy gauge steel (optional aluminum or stainless steel also available on most models).

